

APFEL – 2.0mm HARD METRIC CONNECTORS

Vertical Male Type C Connectors for Fix Boards

Type C vertical male connector provides 55 signal contacts and optional 22 shielding contacts in 5 + 2 row X 11 position. This half-size connector is polarized and the insulator features guides for alignment of the mating connectors.



Dimensions

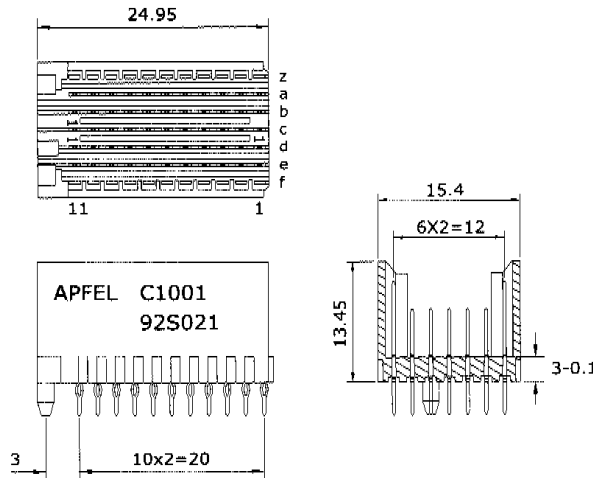

Recommended P.C.B. layout

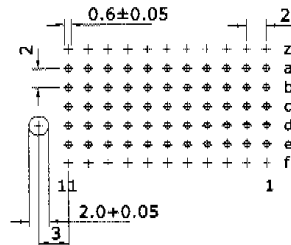

Dimensions shown are for reference purpose only. All dimensions are in millimeters unless otherwise specified.

Apfel-Europe (a division of Westfield Distribution Ltd) (E&OE)

TEL: +44(0)1488 685183 E-mail: sales@apfel.co.uk FAX: +44(0)1488 685430

Disclaimer – Due to technical progress, all designs, specifications, data sheets and components are subject to change without notice. All product information contained in this catalogue / data sheet is for information only – NOT SPECIFICATION. Please call / fax / e-mail for samples and full engineering drawings. Certificates of conformance issued if required.

APFEL – 2.0mm HARD METRIC CONNECTORS

Vertical Male Type C Connectors for Fix Boards

Ordering Information

Assembly Drawing	Total Number	Row	Type	Part Numbers
	55	z a b c d e f	- 1A 1A 1A 1A 1A -	2CM55P1001-0-H
	55	z a b c d e f	- 1B 1B 1B 1B - -	2CM55P1002-0-H
	77	z a b c d e f	1C 1A 1A 1A 1A 1A 1C	2CM77P1001-1-H
	77	z a b c d e f	1C 1B 1B 1B 1B 1B 1C	2CM77P1002-1-H

Male Contact Options

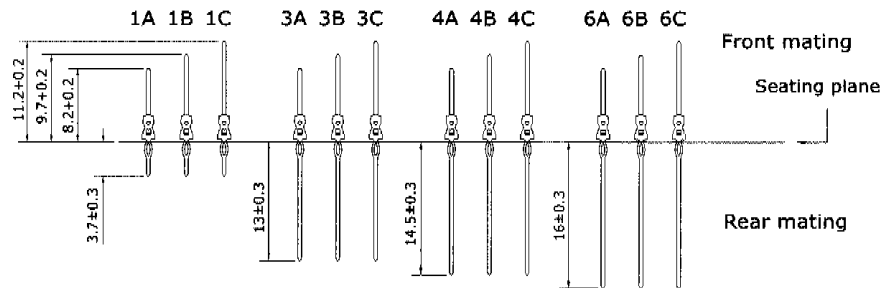

Apfel-Europe (a division of Westfield Distribution Ltd) (E&OE)

TEL: +44(0)1488 685183 E-mail: sales@apfel.co.uk FAX: +44(0)1488 685430

Disclaimer – Due to technical progress, all designs, specifications, data sheets and components are subject to change without notice. All product information contained in this catalogue / data sheet is for information only – NOT SPECIFICATION. Please call / fax / e-mail for samples and full engineering drawings. Certificates of conformance issued if required.

APFEL – 2.0mm HARD METRIC CONNECTORS

Shrouds for Type A/B/C Vertical Male Connectors

Shrouds are fitted over the secondary side of a connectors with extended length of tails to provide a protected mating interface and compensate for a range of backplane thickness. Shrouds with 6 different base thickness are provided for application in various thickness of backplane.



Ordering Information

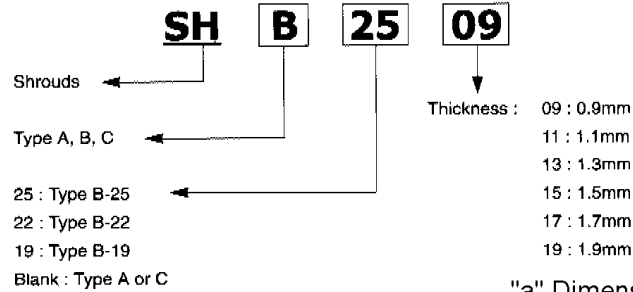

"a" Dimension please refer to Page 28

Dimensions shown are for reference purpose only. All dimensions are in millimeters unless otherwise specified.

please see next page for more information.

Apfel-Europe (a division of Westfield Distribution Ltd) (E&OE)

TEL: +44(0)1488 685183 E-mail: sales@apfel.co.uk FAX: +44(0)1488 685430

Disclaimer – Due to technical progress, all designs, specifications, data sheets and components are subject to change without notice. All product information contained in this catalogue / data sheet is for information only – NOT SPECIFICATION. Please call / fax / e-mail for samples and full engineering drawings. Certificates of conformance issued if required.

APFEL – 2.0mm HARD METRIC CONNECTORS

Shielding Covers

Upper ground return shield could be pre-installed to the female connectors, the lower shields are provided and assembled separately after installing of the connectors onto the printed circuit board as required. Both the upper and lower shielding covers could be ordered separately.



Dimensions Upper Shields

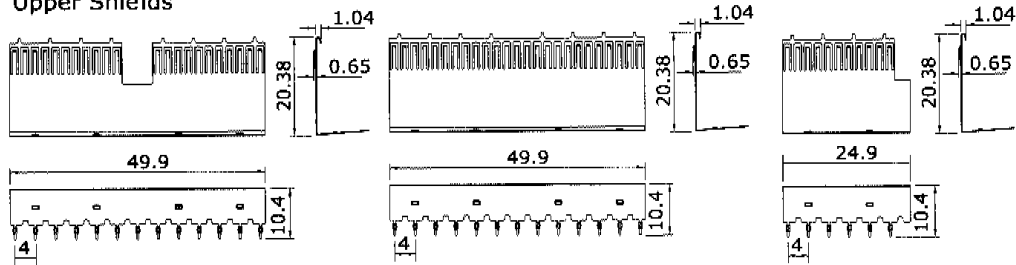

Lower Shields

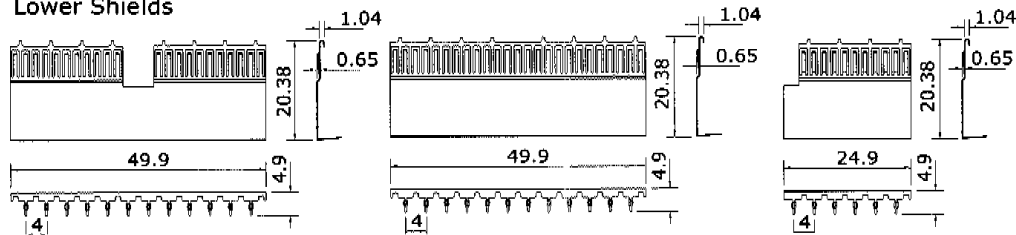

Ordering Information

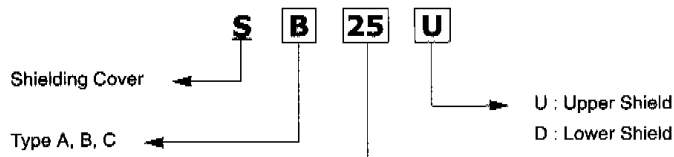

Dimensions shown are for reference purpose only. All dimensions are in millimetres unless otherwise specified.

Apfel-Europe (a division of Westfield Distribution Ltd) (E&OE)

TEL: +44(0)1488 685183 E-mail: sales@apfel.co.uk FAX: +44(0)1488 685430

Disclaimer – Due to technical progress, all designs, specifications, data sheets and components are subject to change without notice. All product information contained in this catalogue / data sheet is for information only – NOT SPECIFICATION. Please call / fax / e-mail for samples and full engineering drawings. Certificates of conformance issued if required.

APFEL – 2.0mm HARD METRIC CONNECTORS

Application Toolings

Male Connector Insertion

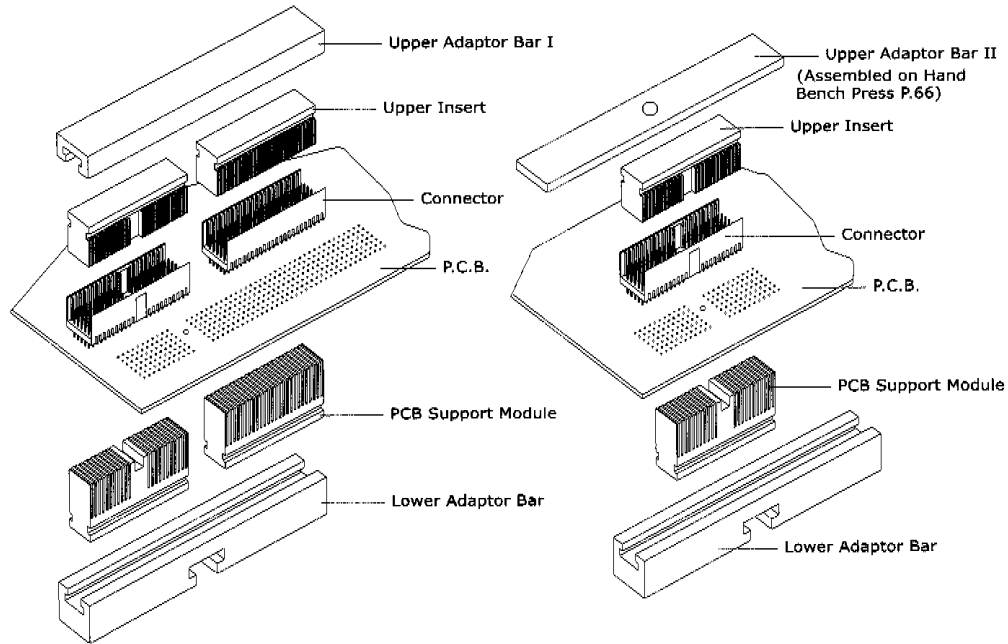

- For Compact PCI Application

Ordering Information

Description

Upper Adaptor Bar I
 Upper Adaptor Bar II
 Upper Insert — Type A
 Upper Insert — Type B25
 Upper Insert — Type B22
 Upper Insert — Type B19
 Upper Insert — Type C
 PCB Support Module — Type A
 PCB Support Module — Type B25
 PCB Support Module — Type B22
 PCB Support Module — Type B19
 PCB Support Module — Type C
 Lower Adaptor Bar

Tool Part Number

2HB I
 2HB II
 2T1TA
 2T1TB25
 2T1TB22
 2T1TB19
 2T1TC
 2BTA
 2BTB25
 2BTB22
 2BTB19
 2BTC
 2BHB

Apfel-Europe (a division of Westfield Distribution Ltd) (E&OE)

TEL: +44(0)1488 685183 E-mail: sales@apfel.co.uk FAX: +44(0)1488 685430

Disclaimer – Due to technical progress, all designs, specifications, data sheets and components are subject to change without notice. All product information contained in this catalogue / data sheet is for information only – NOT SPECIFICATION. Please call / fax / e-mail for samples and full engineering drawings. Certificates of conformance issued if required.

APFEL – 2.0mm HARD METRIC CONNECTORS

Custom Enquiry Form

Date: _____

Company:..... **Tel:**.....

Your Name:..... **Fax:**.....

Address:..... **E-mail:**.....

..... **Sample Qty Required:**.....

Estimated Annual Usage:.....

Fill in diagram below with designated contact types required. Unfilled positions to be left blank.

Type A Connector

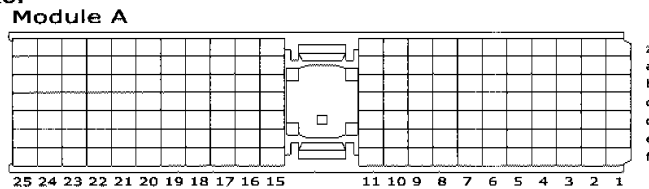

Type B Connector

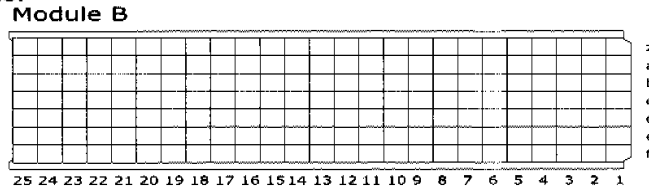

Type C Connector

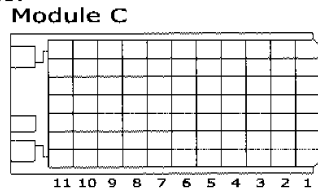

Type M Connector

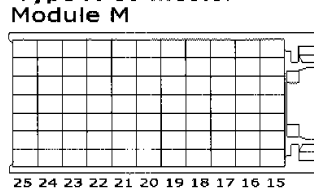

Pin Options

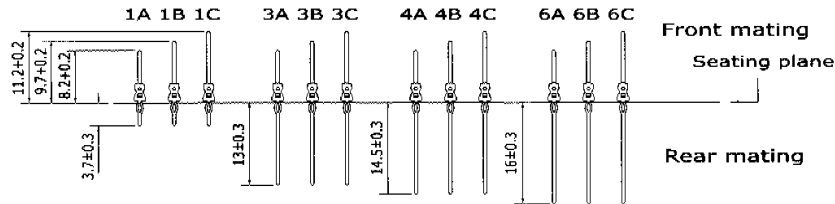

Apfel/Competition Part Number(s):.....

PLEASE FAXBACK / POST / E-MAIL TO US FOR A RAPID RESPONSE! THANK YOU.

Apfel-Europe (a division of Westfield Distribution Ltd) (E&OE)

TEL: +44(0)1488 685183 E-mail: sales@apfel.co.uk FAX: +44(0)1488 685430

Disclaimer – Due to technical progress, all designs, specifications, data sheets and components are subject to change without notice. All product information contained in this catalogue / data sheet is for information only – NOT SPECIFICATION. Please call / fax / e-mail for samples and full engineering drawings. Certificates of conformance issued if required.

APFEL – 2.0mm HARD METRIC CONNECTORS

STANDARD PRODUCT ENQUIRY FORM

Faxback to Apfel-Europe on: +44 (0) 1488 685430

Or telephone +44 (0) 1488 685183

SAMPLES / QUOTATION / TECHNICAL ASSISTANCE ON THE FOLLOWING:

Your Part No	Competition Part No	Apfel Part No	Qty per mth/yr

Notes / Descriptions:.....

.....
.....
.....
.....

Your Name:.....

Company:.....

Address:.....

.....

Tel:..... Fax:.....

E-Mail:

Apfel-Europe (a division of Westfield Distribution Ltd) (E&OE)

32

TEL: +44(0)1488 685183 E-mail: sales@apfel.co.uk FAX: +44(0)1488 685430

Disclaimer – Due to technical progress, all designs, specifications, data sheets and components are subject to change without notice. All product information contained in this catalogue / data sheet is for information only – NOT SPECIFICATION. Please call / fax / e-mail for samples and full engineering drawings. Certificates of conformance issued if required.