

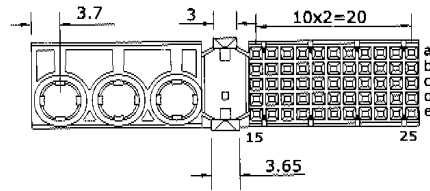

# APFEL – 2.0mm HARD METRIC CONNECTORS

## Dimensions Type M



## Recommended P.C.B. layout Type M

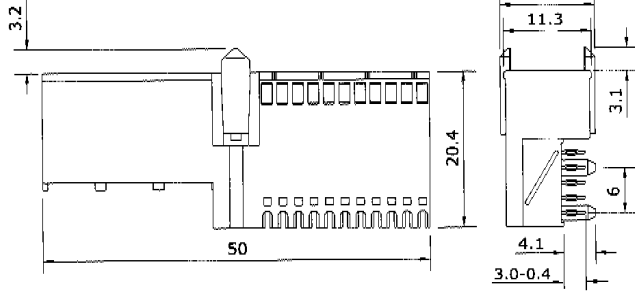
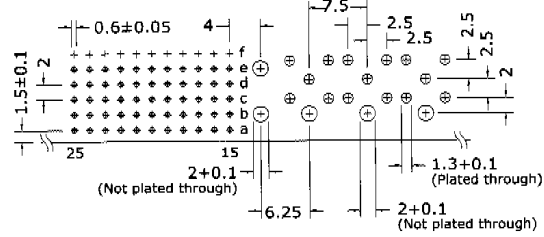

## Dimensions Type N

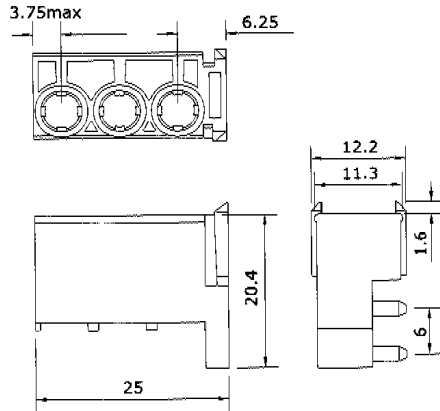

## Recommended P.C.B. layout Type N

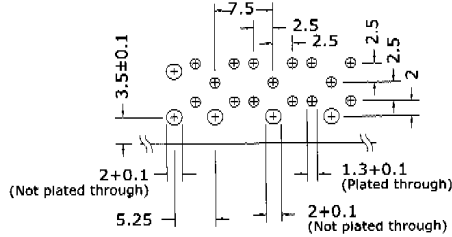

Dimensions shown are for reference purpose only. All dimensions are in millimetres unless otherwise specified

**Apfel-Europe** (a division of Westfield Distribution Ltd) (E&OE)

TEL: +44(0)1488 685183 E-mail: [sales@apfel.co.uk](mailto:sales@apfel.co.uk) FAX: +44(0)1488 685430

Disclaimer – Due to technical progress, all designs, specifications, data sheets and components are subject to change without notice. All product information contained in this catalogue / data sheet is for information only – NOT SPECIFICATION. Please call / fax / e-mail for samples and full engineering drawings. Certificates of conformance issued if required.

# APFEL – 2.0mm HARD METRIC CONNECTORS

## CODING KEYS

Coding keys are snapped into both male and female of MPC (Multipurpose Center) in the Type A, L and M connectors to prevent damage to the system resulted from incorrect insertion of cards. Only connector pairs equipped matching coding keys are intermateable. The unique color of the coding pairs provides easy visual identification of the correct mating connectors.

### Ordering Information

Coding Key	Code Number	Color	Part Number	Coding Key	Code Number	Color	Part Number
	3568	Pastel orange	PMC3568		1247	Pastel orange	RMC1247
	3478	Steel Blue	PMC3478		1256	Steel Blue	RMC1256
	3467	Slate grey	PMC3467		1258	Slate grey	RMC1258
	3456	Cadmium yellow	PMC3456		1278	Cadmium yellow	RMC1278
	2578	Reseda green	PMC2578		1346	Reseda green	RMC1346
	1567	Brilliant blue	PMC1567		2348	Brilliant blue	RMC2348
	1356	Blue/lilac	PMC1356		2478	Blue/lilac	RMC2478
	4678	Ochre yellow	PMC4678		1235	Ochre yellow	RMC1235
	1248	Strawberry red	PMC1248		3567	Strawberry red	RMC3567
	1236	Nut brown	PMC1236		4578	Nut brown	RMC4578

The color/code number combinations listed above follow IEC61076-4-101 recommendation.  
Consult factory for other versions.

**Apfel-Europe** (a division of Westfield Distribution Ltd) (E&OE)

29

TEL: +44(0)1488 685183 E-mail: [sales@apfel.co.uk](mailto:sales@apfel.co.uk) FAX: +44(0)1488 685430

Disclaimer – Due to technical progress, all designs, specifications, data sheets and components are subject to change without notice. All product information contained in this catalogue / data sheet is for information only – NOT SPECIFICATION. Please call / fax / e-mail for samples and full engineering drawings. Certificates of conformance issued if required.

# APFEL – 2.0mm HARD METRIC CONNECTORS

## Application Toolings

### Male Connector Insertion

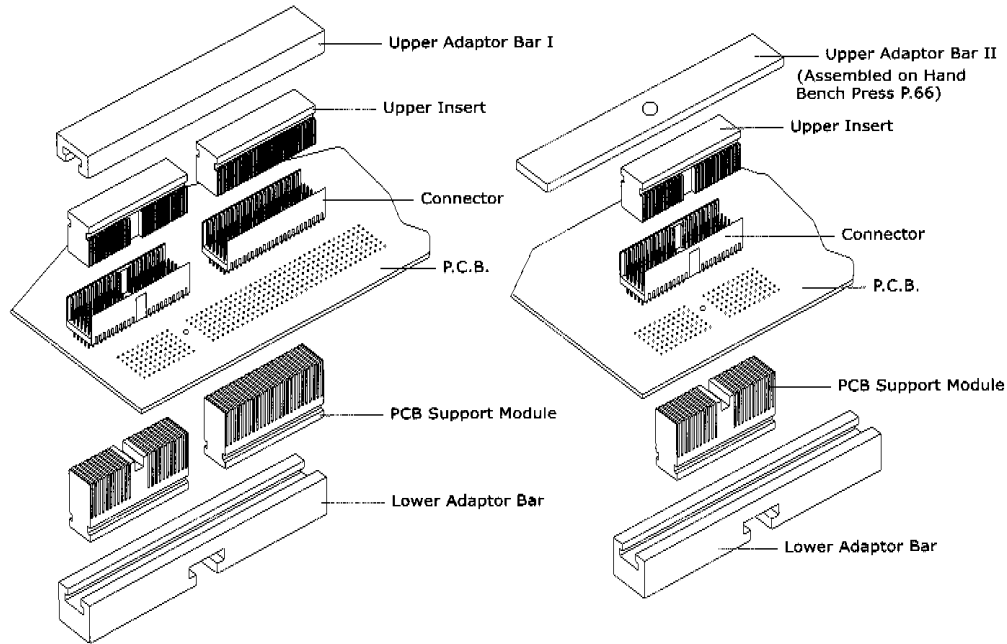

- For Compact PCI Application

### Ordering Information

#### Description

Upper Adaptor Bar I  
Upper Adaptor Bar II  
Upper Insert — Type A  
Upper Insert — Type B25  
Upper Insert — Type B22  
Upper Insert — Type B19  
Upper Insert — Type C  
PCB Support Module — Type A  
PCB Support Module — Type B25  
PCB Support Module — Type B22  
PCB Support Module — Type B19  
PCB Support Module — Type C  
Lower Adaptor Bar

#### Tool Part Number

2HB I  
2HB II  
2T1TA  
2T1TB25  
2T1TB22  
2T1TB19  
2T1TC  
2BTA  
2BTB25  
2BTB22  
2BTB19  
2BTC  
2BHB

**Apfel-Europe** (a division of Westfield Distribution Ltd) (E&OE)

TEL: +44(0)1488 685183 E-mail: [sales@apfel.co.uk](mailto:sales@apfel.co.uk) FAX: +44(0)1488 685430

Disclaimer – Due to technical progress, all designs, specifications, data sheets and components are subject to change without notice. All product information contained in this catalogue / data sheet is for information only – NOT SPECIFICATION. Please call / fax / e-mail for samples and full engineering drawings. Certificates of conformance issued if required.

# APFEL – 2.0mm HARD METRIC CONNECTORS

**Custom Enquiry Form**

**Date:** \_\_\_\_\_

**Company:**..... **Tel:**.....

**Your Name:**..... **Fax:**.....

**Address:**..... **E-mail:**.....

..... **Sample Qty Required:**.....

**Estimated Annual Usage:**.....

Fill in diagram below with designated contact types required. Unfilled positions to be left blank.

**Type A Connector**

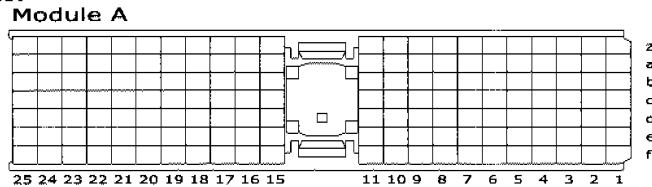

**Type B Connector**

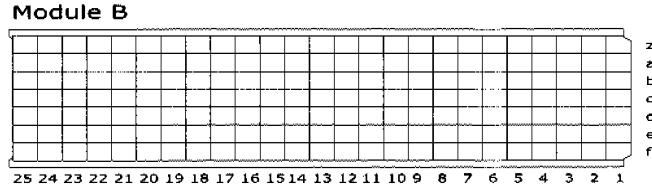

**Type C Connector**

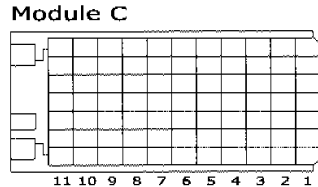

**Type M Connector**

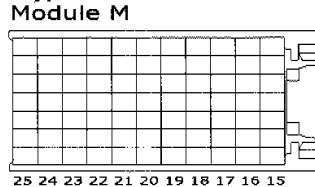

**Pin Options**

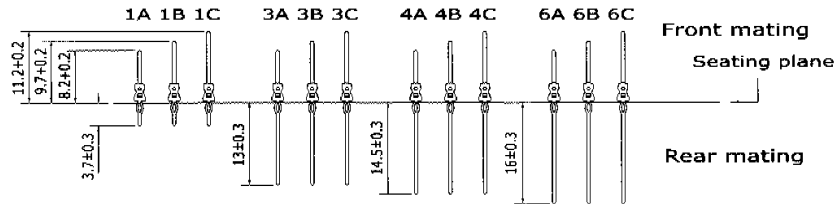

**Apfel/Competition Part Number(s):**.....

PLEASE FAXBACK / POST / E-MAIL TO US FOR A RAPID RESPONSE! THANK YOU.

**Apfel-Europe** (a division of Westfield Distribution Ltd) (E&OE)

**TEL: +44(0)1488 685183 E-mail: sales@apfel.co.uk FAX: +44(0)1488 685430**

*Disclaimer – Due to technical progress, all designs, specifications, data sheets and components are subject to change without notice. All product information contained in this catalogue / data sheet is for information only – NOT SPECIFICATION. Please call / fax / e-mail for samples and full engineering drawings. Certificates of conformance issued if required.*

# APFEL – 2.0mm HARD METRIC CONNECTORS

## STANDARD PRODUCT ENQUIRY FORM

Faxback to Apfel-Europe on: +44 (0) 1488 685430

Or telephone +44 (0) 1488 685183

SAMPLES / QUOTATION / TECHNICAL ASSISTANCE ON THE FOLLOWING:

Your Part No	Competition Part No	Apfel Part No	Qty per mth/yr

Notes / Descriptions:.....

.....  
.....  
.....  
.....

Your Name:.....

Company:.....

Address:.....

.....

Tel:..... Fax:.....

E-Mail: .....

**Apfel-Europe** (a division of Westfield Distribution Ltd) (E&OE)

32

TEL: +44(0)1488 685183 E-mail: [sales@apfel.co.uk](mailto:sales@apfel.co.uk) FAX: +44(0)1488 685430

Disclaimer – Due to technical progress, all designs, specifications, data sheets and components are subject to change without notice. All product information contained in this catalogue / data sheet is for information only – NOT SPECIFICATION. Please call / fax / e-mail for samples and full engineering drawings. Certificates of conformance issued if required.